



METER

# TEROS 31

# TABLE OF CONTENTS

<b>1. Introduction</b>	<b>1</b>
<b>2. Operation</b>	<b>2</b>
2.1 Installation	2
2.1.1 Installation Angle	6
2.1.2 Installation Depth	6
2.1.3 Drilling with the TEROS 31 Auger	9
2.2 Filling the Tensiometer Shaft and Sensor Unit	9
2.3 Connecting	13
2.3.1 Connect to METER Data Logger	13
2.3.2 Connect to Non-METER Data Logger	13
2.4 Communication	15
2.5 Removal	16
<b>3. System</b>	<b>17</b>
3.1 Specifications	17
3.2 Components	20
3.3 Theory	21
3.3.1 Water Potential Measurements	21
3.3.2 Barometric Compensation	21
3.3.3 Measurement Range	22
3.3.4 Temperature	24

<b>4. Service</b> .....	25
4.1 Calibration .....	25
4.2 Recalibration Recommendations.....	25
4.2.1 Checking Water Potential Accuracy .....	25
4.2.2 Replacing the O-ring Inside the Sensor Unit .....	25
4.2.3 Offset Correction .....	26
4.2.4 Cleaning.....	28
4.3 Troubleshooting.....	28
4.4 Customer Support.....	29
4.5 Terms and Conditions .....	30
<b>Index</b> .....	31

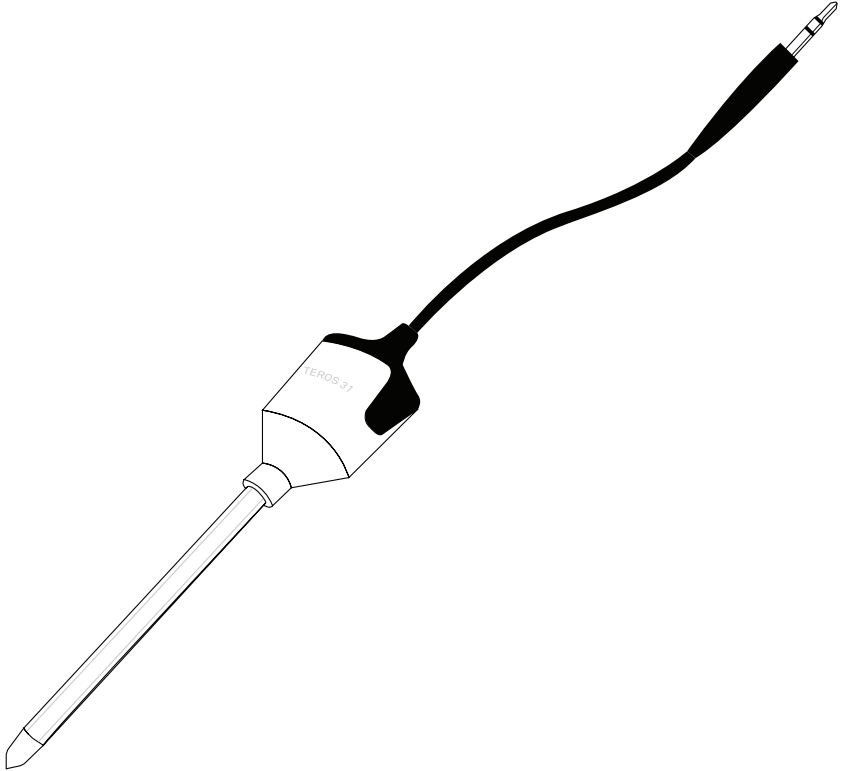

# 1. INTRODUCTION

Thank you for choosing the TEROS 31 Soil Water Potential and Temperature sensor from METER Group.

TEROS 31 sensors measure the soil water potential and temperature. TEROS 31 applications include measuring soil water availability, controlling irrigation, and measuring soil–water storage.

The TEROS 31 sensor is designed for soil columns, plant pots, laboratory lysimeters, and point measurements. With an active surface of only 0.5 cm<sup>2</sup> and a diameter of 5 mm, the ceramic tip has all advantages of small dimensions: little soil disturbance, selective pick-up, and fast response. The very thin and highly flexible cable transfers minimal force to the sensor unit and tensiometer shaft. The TEROS 31 can be installed in nearly every position and no stiff cable will interrupt the measurement or loosen the sensor in the soil.

This manual guides the customer through the sensor features and describes how to use the sensor successfully.

Verify all TEROS 31 components are included and appear in good condition:

- Tensiometer
- Protective cap
- Spare O-rings
- TEROS 31 refill unit, if ordered

METER recommends testing the sensors with the data logging device and software before installation.

## 2. OPERATION

Please read all instructions before operating the TEROS 31 to ensure it performs to its full potential.

### PRECAUTIONS

METER sensors are built to the highest standards. Misuse, improper protection, or improper installation may damage the sensor and possibly void the manufacturer's warranty. Before integrating the TEROS 31 into a system, follow the recommended installation instructions and have the proper protections in place to safeguard sensors from damage. If installing sensors in a lightning-prone area with a grounded data logger, see the application note [Lightning surge and grounding practices](#).

## 2.1 INSTALLATION

When selecting a site for installation, it is important to remember that the soil adjacent to the sensor surface has the strongest influence on the sensor reading.

Consider the following items before installing TEROS 31:

- **Ceramic tip.** Do not touch the ceramic tip. Skin oil, sweat, or soap residues will influence the ceramic hydrophilic performance.
- **Freezing temperatures.** Tensiometers are filled with water and therefore are susceptible to freezing! Never leave tensiometers exposed when freezing temperatures might occur! Refilling the sensor may not be possible under freezing temperatures.
- **Electrical installation.** If connecting the data logger to a main power supply, consult qualified personnel.

Follow the steps listed in [Table 1](#) to set up the TEROS 31 and start collecting data.

**Table 1 Installation**

<b>Tools Needed</b>	TEROS 31 refill unit (order separately)
	Deionized water Tensiometer auger (order separately)
<b>Preparation</b>	<b>Determine Installation Configuration</b> Decide installation angle ( <a href="#">Section 2.1.1</a> ). Calculate installation depth ( <a href="#">Section 2.1.2</a> ).
	<b>NOTE:</b> A barometric reference sensor, either standalone or as part of a data logger, is needed as part of the system configuration to accurately measure soil water potential ( <a href="#">Section 3.3.2</a> ).

**Table 1 Installation (continued)**

<b>Preparation (continued)</b>	<p><b>Fill the Tensiometer</b></p> <p><b>NOTE:</b> More details of this process are in <a href="#">Section 2.2</a>.</p> <p>Fill a beaker in the TEROS 31 refill unit with deionized water.</p> <p>Unscrew the TEROS 31 shaft from the TEROS 31 sensor unit.</p> <p>Connect the TEROS 31 shaft into the shaft adapter, and connect the adapter to the refill syringe.</p> <p>Put the shaft into the beaker, and pull the syringe plunger until the spacers snap in.</p> <p>Leave the shaft and ceramic tip in the beaker for several hours.</p> <p>Connect the TEROS 31 sensor unit to the sensor unit adapter.</p> <p>Fill the second refill syringe with deionised water and connect the syringe to the sensor unit adapter.</p> <p>Pull the syringe plunger and let the plunger move back slowly to replace the air inside the adapter with water.</p> <p>Pull up the plunger until the spacers snap in.</p> <p>Put the sensor unit into the refill unit rack and let the sensor unit degas for several hours. Dislodge air bubbles from time to time.</p> <p>Remove the adapter from the sensor unit.</p> <p>Remove the adapter from the shaft.</p> <p>Screw the shaft carefully into the sensor unit.</p> <p>Put the TEROS 31 in the beaker again to lower the accrued overpressure for about 1 h.</p> <p>After successful refill, keep the ceramic tip wet until installation. Use the protective cap for longer storage time.</p> <p><b>Conduct System Check</b></p> <p>Plug the sensor into the logger (<a href="#">Section 2.3</a>) to make sure the sensor is functional.</p>	
	<b>Installation</b>	<p><b>Create Hole</b></p> <p>Avoid interfering objects, such as roots or rocks.</p> <p>Mark the required drilling depth on the TEROS 31 auger (<a href="#">Section 2.1.2</a>).</p> <p>Use a level set or a set square to the predetermined installation angle (<a href="#">Section 2.1.1</a>) to ensure the auger is drilling at the correct angle.</p> <p>Drill a hole stepwise until the marker reaches the soil surface (<a href="#">Section 2.1.3</a>). Avoid soil compaction by drilling with several steps (maximum drilling step length = blade length of TEROS 31 auger).</p>

Table 1 Installation (continued)

Installation (continued)	<p><b>Insert Sensor</b></p> <p><b>NOTE:</b> Do not touch the ceramic tip. Skin oil, sweat, or soap residues will affect its hydrophilic performance.</p> <p>Carefully and slowly insert the TEROS 31 into the borehole until the drilling depth is reached.</p> <p><b>Secure and Protect Cables</b></p> <p><b>NOTE:</b> Improperly protected cables can lead to severed cables or disconnected sensors. Cabling issues can be caused by many factors such as rodent damage, driving over sensor cables, tripping over cables, not leaving enough cable slack during installation, or poor sensor wiring connections.</p> <p>Install cables in conduit or plastic cladding when near the ground to avoid rodent damage.</p> <p>Gather and secure cables between the TEROS 31 and the data logger to the mounting mast in one or more places.</p> <p><b>Connect to Logger</b></p> <p>Plug the sensor into a data logger.</p> <p>Use the data logger to make sure the sensor is reading properly.</p> <p>Verify that these readings are within expected ranges.</p> <p>For more specific instructions on connecting to data loggers, refer to <a href="#">Section 2.3</a>.</p> <p><b>NOTE:</b> Electrical installations must comply with the safety and EMC requirements of the country in which the system is to be used.</p>
-----------------------------	---

[Table 2](#) contains brief descriptions for typical installation methods for different measurement tasks. Each has its own advantages and disadvantages. For more information about which installation method is best for specific applications, please contact [Customer Support](#).

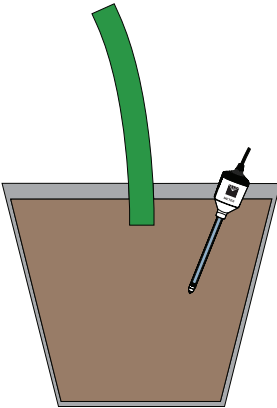
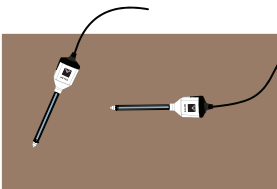

Table 2 Installation methods

From Soil Surface			
<p>To dig a borehole of the proper size, use the TEROS 31 auger (Section 2.1.3).</p> <p>This method works best for plant pots or undisturbed measurement sites, as the sensor cable is exposed and easily accessible.</p>		<p><b>Advantage</b></p> <p>Minimizes soil disturbance at measurement site.</p> <p>Sensor can be easily removed for refill or maintenance.</p>	<p><b>Disadvantage</b></p> <p>Sensor unit, shaft and cable can be damaged.</p> <p>Requires longer shafts.</p> <p>The shaft may act as a preferential water flow.</p> <p>Solar radiation may heat up sensor unit. Measured temperature may diverge from the soil temperature.</p>
Buried			
<p>This method is recommended if the sensor unit or cable should not reach to the soil surface or for deeper installation depths than the maximum shaft length.</p> <p>After digging a hole, METER recommends using the TEROS 31 auger to drill a borehole the right size (Section 2.1.3).</p> <p>In backfilled soil columns, TEROS 31 can be installed while filling the column vessel. Be sure not to injure the cable while packing the soil above the sensor.</p>		<p><b>Advantage</b></p> <p>Sensors are protected from damage at the surface.</p> <p>Sensors can be installed in frost-free zone.</p> <p>Sensors can be installed at a greater depth than the tensiometer shaft reaches.</p> <p>TEROS 31 temperature sensor measures the soil temperature.</p>	<p><b>Disadvantage</b></p> <p>Large soil disturbance at measurement site.</p> <p>Sensor refilling or maintenance requires digging up the TEROS 31.</p>

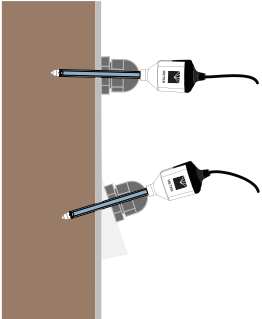
Laboratory		Advantage	Disadvantage
<p>TEROS 31 are particularly suitable for laboratory lysimeters or soil columns. The tensiometer shaft can be installed from outside through the vessel wall. A cable gland will be needed to tighten the vessel.</p> <p>Use the TEROS 31 auger for drilling a borehole the right size.</p>		<p>Minimizes soil disturbance at measurement site.</p> <p>Sensor can be easily removed for refill or maintenance.</p> <p>TEROS 31 can be installed at any position in the lysimeter.</p>	<p>Sensor unit, shaft, and cable can be damaged.</p> <p>Solar radiation may heat the sensor unit. Measured temperature may diverge from the soil temperature.</p>

### 2.1.1 INSTALLATION ANGLE

TEROS 31 can be installed at any angle. The exact installation angle will depend on the individual measuring task, site, and depth. An angled installation position does not disturb typical water flow and avoids creating preferential water flow along the shaft.

### 2.1.2 INSTALLATION DEPTH

Figure 1 shows the reference point for water potential measurement. Water potential is calibrated to the middle of the ceramic tip.

Use the reference point to determine the best installation depth for the desired application. If TEROS 31 is installed at an angle from horizontal ( $\alpha$ ), installation depth is not equal to drilling depth. To calculate the correct drilling depth, use Equation 1 or Table 3.

$$\text{drilling depth} = \frac{\text{installation depth}}{\sin \alpha} \quad \text{Equation 1}$$

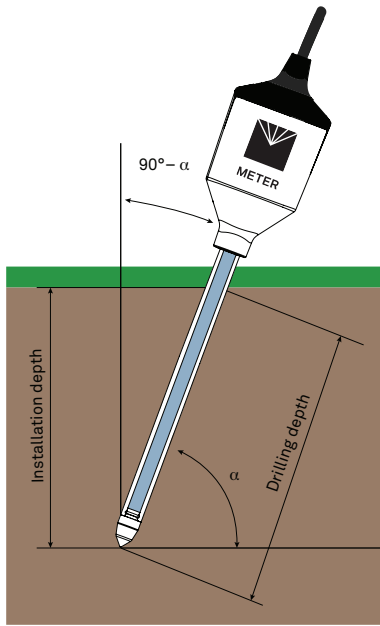

Figure 1 Drilling depth depending on installation angle

## OPERATION

**Table 3 Drilling depth in centimeters for installation depths and angles**

	Installation Angle																
	85°	80°	75°	70°	65°	60°	55°	50°	45°	40°	35°	30°	25°	20°	15°	10°	5°
Installation Depth	1	1	1	1	1	1	1	1	1	2	2	2	2	3	4	6	11
	2	2	2	2	2	2	2	3	3	3	3	4	5	6	8	12	23
	3	3	3	3	3	3	4	4	4	5	5	6	7	9	12	17	
	4	4	4	4	4	5	5	5	6	6	7	8	9	12	15	23	
	5	5	5	5	5	6	6	6	7	7	8	9	10	12	15	19	
	6	6	6	6	6	7	7	7	8	8	9	10	12	14	18	23	
	7	7	7	7	7	8	8	9	9	10	11	12	14	17	20		
	8	8	8	8	9	9	9	10	10	11	12	14	16	19	23		
	9	9	9	9	10	10	10	11	12	13	14	16	18	21			
	10	10	10	10	11	11	12	12	13	14	16	17	20	24			
	11	11	11	11	12	12	13	13	14	16	17	19	22				
	12	12	12	12	13	13	14	15	16	17	19	21	24				
	13	13	13	13	14	14	15	16	17	18	20	23					
	14	14	14	14	15	15	16	17	18	20	22						
	15	15	15	16	16	17	17	18	20	21	23						
	16	16	16	17	17	18	18	20	21	23							
	17	17	17	18	18	19	20	21	22								
	18	18	18	19	19	20	21	22									
	19	19	19	20	20	21	22	23									
	20	20	20	21	21	22	23										

### 2.1.3 DRILLING WITH THE TEROS 31 AUGER

METER recommends using only the specially designed tensiometer auger for installing the TEROS 31 (order separately). This will result in good hydraulic contact with the soil and minimised soil compaction. The tensiometer auger is specially shaped to prevent soil compaction near the ceramic area (Figure 2).

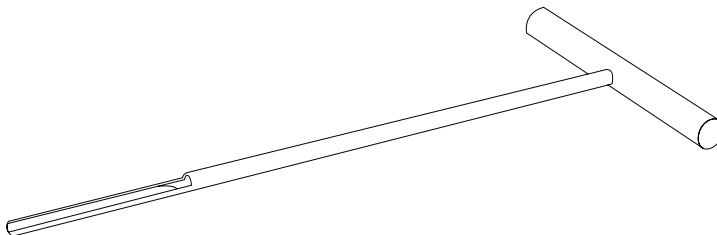

Figure 2 TEROS 31 auger

The following steps detail how to use the tensiometer auger:

1. Place the auger tip on the ground and adjust to the calculated installation angle using a level or set square as a guide.
2. Push the auger into the ground while drilling slowly for about 40 mm.
3. Rotate the auger one revolution clockwise to cut off the soil in the borehole.
4. Pull the auger out of the borehole after every 40-mm increment to avoid soil compaction.
5. Remove the soil inside the auger head.
6. Repeat [step 2](#) through [step 5](#) until desired depth is reached.

### 2.2 FILLING THE TENSIO METER SHAFT AND SENSOR UNIT

The water potential measurement of TEROS 31 only works properly if the sensor unit, tensiometer shaft, and ceramic tip are completely filled with deionized and degassed water. Any air bubbles inside the sensor unit and shaft will downgrade the quality of the water potential measurement. For refilling, METER recommends using the TEROS 31 refill unit (order separately), which contains a refill unit, four syringes, two shaft adapters, and two sensor unit adapters.

TEROS 31 sensors are delivered unfilled. The sensor will need to be filled prior to first use.

Use only deionised or distilled water to get the complete measurement range for water potential measurements. Using tap water may contaminate the pressure transducer and ceramic tip.

**NOTE:** Do not touch the ceramic tip. Skin oil, sweat, or soap residues will affect its hydrophilic performance.

1. Fill the beaker with deionised or distilled water and place it in the refill unit.
2. Disassemble the TEROS 31 and separate the shaft and sensor unit.

## OPERATION

3. Screw the TEROS 31 shaft into the shaft adapter and connect the adapter to the refill syringe.
4. Put the TEROS 31 shaft into the beaker and pull the syringe plunger upwards until the spacers snap into place.
5. Connect the TEROS 31 sensor unit to the sensor unit adapter.
6. Fill a second refill syringe with about 5 mL of deionised or distilled water.
7. Connect the syringe to the sensor unit adapter ([Figure 3](#)).

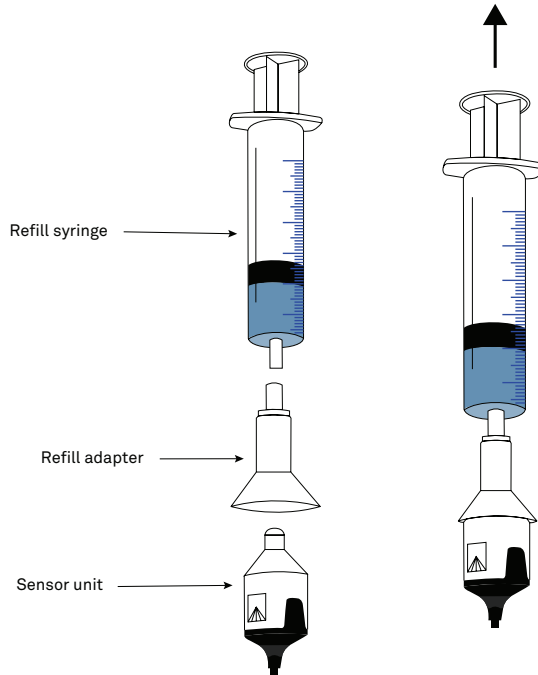

**Figure 3** Connect refill syringe to TEROS 31 refill adapter

8. Pull up on the plunger until the spacers snap in.
9. While holding the plunger and syringe, unlock the spacers and let the plunger slowly move back down. Some air in the adapter will now be replaced by water.  
**NOTE:** Do not let the plunger snap in as this might damage the pressure transducer.
10. Repeat [step 8](#) and [step 9](#) until the adapter is completely filled with water.
11. Remove the syringe from the adapter.
12. Push out the remaining water from the syringe.
13. Connect the empty syringe to the water filled adapter again and pull the plunger until the spacers snap in.
14. Place the sensor unit in the notch of the refill unit ([Figure 4](#)).

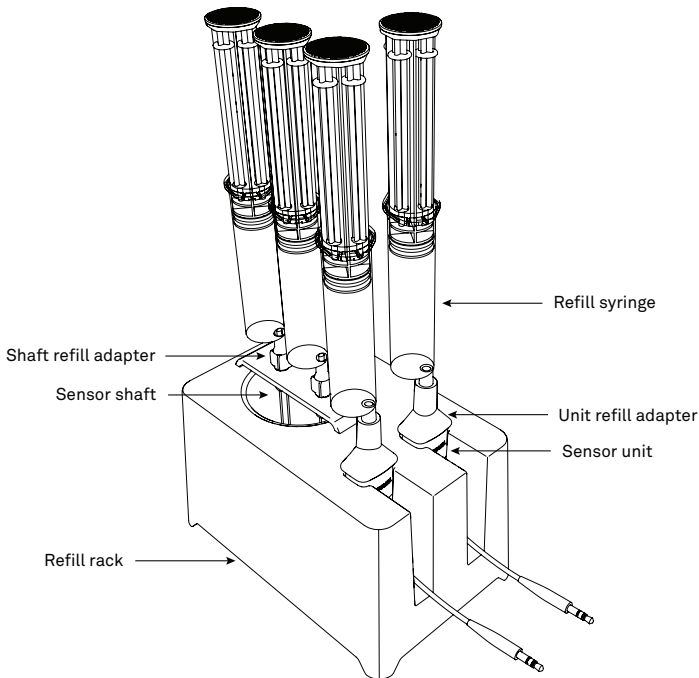
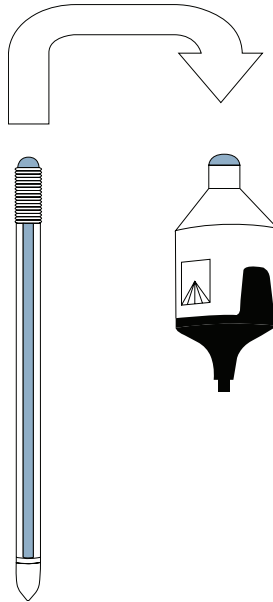

**Figure 4 Refill unit and syringes with TEROS 31 sensors**

15. The sensor unit should be degassed for a few hours (until no air bubbles are visible in the adapter). From time to time, tap the sensor unit to loosen any air bubbles. Keep the shaft in the beaker until the whole shaft is filled with water. From time to time, remove the shaft and tap the shaft to loosen air bubbles from the ceramic cup and the shaft wall. Depending on the shaft length, METER recommends leaving the shaft in water from several hours to overnight. When the shaft is filled with water and the sensor unit is properly degassed, the TEROS 31 can be reassembled.
 

**NOTE:** Completely dried out ceramics may need more refilling time for all air bubbles to leave the ceramic.
16. Leaving the sensor unit in the refill unit, disconnect the syringe adapter from the sensor unit.
17. Put a few drops of degassed and deionized water onto the sensor unit shaft connector until a meniscus forms (Figure 5).
18. Remove the TEROS 31 shaft from the beaker.
19. Disconnect the syringe and syringe adapter and set aside.
20. Put a drop of degassed and deionized water on the open end of the shaft so a meniscus forms (Figure 5).

## OPERATION



**Figure 5 Shaft and sensor unit with meniscus**

21. Remove the sensor unit from the refill unit.
22. Bring both water menisci together and insert the shaft into the sensor unit shaft connector.
23. Carefully screw the shaft into the sensor unit until the shaft touches the O-ring inside the sensor unit and pressure will build up.
24. Continue to screw slowly until it is finger tight. Do not use any tools to screw the shaft!
25. Put the TEROS 31 in the water filled beaker again for about 1 h to lower the accrued overpressure.

After successful refilling, keep the ceramic tip wet! Otherwise, water tension will rise up and air bubbles may develop within a few minutes. METER recommends storing the filled tensiometer in a water-filled beaker until the sensor is installed.

For long storage time (the next day or later), use the provided protective cap. Fill the reservoir with deionised water, insert the shaft through the opening, and close the protective cap.

The soil water potential may get higher than the TEROS 31 measuring range ( $-85$  kPa or up to  $-150$  kPa while boiling delay phase; [Section 3.3.3](#)). The water will evaporate from the ceramic tip and the sensor will stop measuring properly. The TEROS 31 should be refilled when the soil is wet again (water potential is lower than  $-85$  kPa). Refilling while soil water potential is higher than  $-85$  kPa will not be successful. The water will evaporate and leave the ceramic tip again shortly after refilling.



## 2.3 CONNECTING

The TEROS 31 works seamlessly with METER data loggers. The TEROS 31 can also be used with other data loggers, such as those from Campbell Scientific, Inc. For extensive directions on how to integrate the sensors into third-party loggers, refer to the [TEROS 31 Integrator Guide](#).

TEROS 31 sensors require an excitation voltage in the range of 3.6 to 28.0 VDC and operate at a 3.6-VDC level for data communication. TEROS 31 can be integrated using DDI serial, SDI-12 protocol, Modbus® RTU protocol, and tensioLINK® protocol. See the [TEROS 31 Integrator Guide](#) for details on interfacing with data acquisition systems.

TEROS 31 sensors come with a 3.5-mm stereo plug connector ([Figure 6](#)) to facilitate easy connection with METER loggers. The TEROS 31 comes standard with a 1.5-m cable.

**NOTE:** The following stereo plug configuration is for TEROS 31 sensors with serial number 500 or higher. For sensors with serial numbers less than 500, contact [Customer Support](#) for more information.

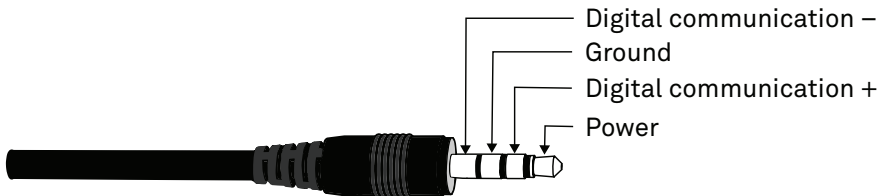

Figure 6 Stereo plug connector

### 2.3.1 CONNECT TO METER DATA LOGGER

The TEROS 31 works most efficiently with METER ZENTRA series data loggers. Check the [METER download webpage](#) for the most recent data logger firmware. Logger configuration may be done using either ZENTRA Utility (desktop and mobile application) or ZENTRA Cloud (web-based application for cell-enabled ZENTRA data loggers).

1. Plug the stereo plug connector into one of the sensor ports on the logger.
2. Use the appropriate software application to configure the chosen logger port for the TEROS 31. METER data loggers will automatically recognize TEROS 31 sensors.
3. Set the measurement interval.

METER data loggers measure the TEROS 31 every minute and return the average of the 1-min data across the chosen measurement interval.

### 2.3.2 CONNECT TO NON-METER DATA LOGGER

The TEROS 31 can be used with non-METER (third-party) data loggers or data acquisition systems. Refer to the third-party logger manual for details on logger communications, power, and ground ports. The TEROS 31 Integrator Guide also provides detailed instructions on connecting sensors to non-METER loggers.

## OPERATION

**NOTE:** A barometric reference sensor, either standalone or as part of a data logger, is needed as part of the system configuration to accurately measure soil water potential ([Section 3.3.2](#)).

Connect pigtail TEROS 31 wires to the data logger as illustrated in [Figure 7](#) and either [Figure 8](#) or [Figure 9](#), depending on the desired protocol. For RS-485, the power supply wire (brown) will be connected to the excitation, the digital communication + wire (orange) to a digital input (high), the digital communication - wire (bare) to a digital input (low) and the blue ground wire to ground. For SDI-12, both the digital communication - and ground wires will both be connected to ground.

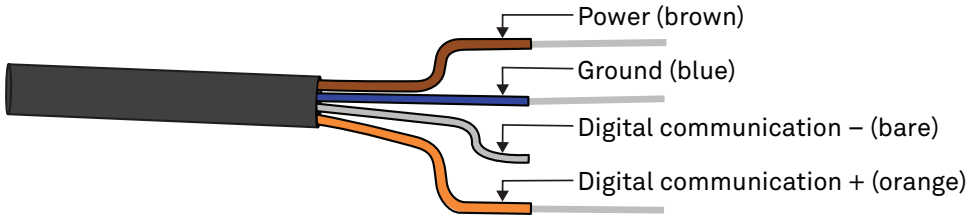

Figure 7 Pigtail wiring

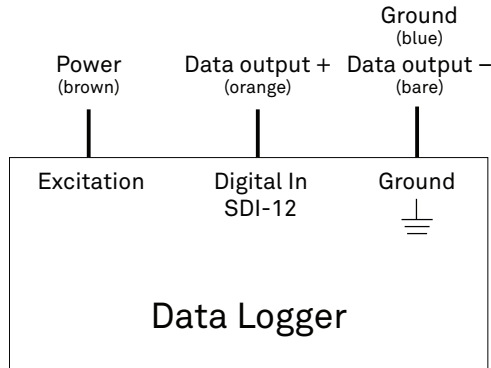

Figure 8 Wiring diagram for SDI-12

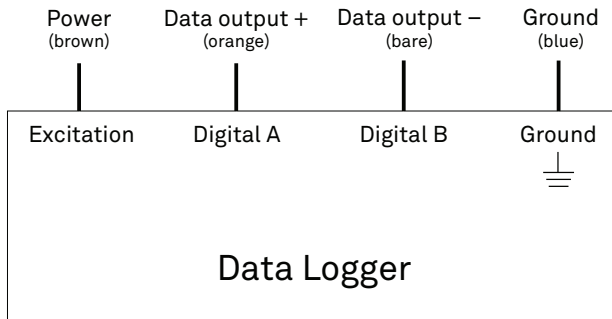

Figure 9 Wiring diagram for RS-485

**NOTE:** The acceptable range of excitation voltages is from 3.6 to 28.0 VDC. To read TEROS 31 with Campbell Scientific data loggers, power the sensors from a switched 12-V port or a 12-V port if using a multiplexer.

If the TEROS 31 cable has a standard stereo plug connector and needs to be connected to a non-METER data logger, use one of the following two options.

### Option 1

1. Clip off the stereo plug connector on the sensor cable.
2. Strip and tin the wires.
3. Wire it directly into the data logger.

This option has the advantage of creating a direct connection with no chance of the sensor becoming unplugged. However, it then cannot be easily used in the future with a METER readout unit or data logger.

### Option 2

Obtain an adapter cable from METER.

The adapter cable has a connector for the stereo plug connector on one end and four wires (or pigtail adapter) for connection to a data logger on the other end. The stripped and tinned adapter cable wires have the same termination as in [Figure 7](#): the brown wire is excitation, the orange is digital output +, the bare is digital output -, and the blue wire is ground.

**NOTE:** Secure the stereo plug connector to the pigtail adapter connections using adhesive-lined heat shrink to ensure the sensor does not become disconnected during use.

## 2.4 COMMUNICATION

The SDI-12 protocol requires that all sensors have a unique address. TEROS 31 sensor factory default is an SDI-12 address of 0. To add more than one SDI-12 sensor to a bus, the sensor address can be changed using a ZSC Bluetooth® sensor interface and the ZENTRA Utility Mobile app as described below:

**NOTE:** The sensor SDI-12 address must be returned to 0 to work with ZENTRA loggers.

1. Using a mobile device, open the ZENTRA Utility Mobile app.
2. Connect the sensor to the ZSC.
3. Under Sensor Information, select the SDI Address dropdown.
4. Scroll through the options and select the desired SDI-12 address.

**NOTE:** Address options include 0-9, A-Z, and a-z.

## OPERATION

TEROS 31 sensors with serial numbers less than 500, cannot be plugged directly into a ZSC Bluetooth® sensor interface. To get a proper connection between the TEROS 31 and the ZSC, use an extension cable with a 4-pin stereo plug connector and 3-pin stereo plug connector. METER has a molded extension cable available; contact [Customer Support](#) for more information.

Detailed information can also be found in the application note [Setting SDI-12 addresses on METER digital sensors using Campbell Scientific data loggers and LoggerNet](#).

When using the sensor as part of an SDI-12 bus, excite the sensors continuously to avoid issues with initial sensor startup interfering with the SDI-12 communications.

## 2.5 REMOVAL

To remove the sensor from the soil, pull gently on the sensor unit until the sensor shaft is out of the soil.

**WARNING: Do not pull by the cable! Doing so may break internal connections and make the sensor unusable.**

## 3. SYSTEM

This section describes the TEROS 31 Soil Water Potential and Temperature system.

### 3.1 SPECIFICATIONS

#### MEASUREMENT SPECIFICATIONS

##### Water Potential

Range	-85 to +50 kPa (up to -150 kPa during boiling retardation)
-------	---

Resolution	±0.0012 kPa
------------	-------------

Accuracy	±0.15 kPa
----------	-----------

##### Temperature

Range	-30 to +60 °C
-------	---------------

Resolution	±0.01 °C
------------	----------

Accuracy	±0.5 °C
----------	---------

**NOTE:** If the sensor unit is not buried, measured temperature may diverge from soil temperature.

#### COMMUNICATION SPECIFICATIONS

##### Output

- DDI Serial
- SDI-12 communication protocol
- tensiolINK® communication protocol
- Modbus® RTU communication protocol

##### Data Logger Compatibility

METER ZL6 and EM60 data loggers or any data acquisition system capable of 3.6- to 28.0-VDC excitation and SDI-12, Modbus RTU, or tensioLINK communication.

#### PHYSICAL SPECIFICATIONS

##### Dimensions

Width	23.5 mm (0.93 in)
-------	-------------------

Depth	17.5 mm (0.69 in)
-------	-------------------

Height	49.0 mm (1.93 in)
--------	-------------------

##### Shaft Diameter

5 mm (0.19 in)

**Shaft Length**

2, 5, 7, 10, 15, or 20 cm

**Operating Temperature Range**

Minimum 0 °C

Maximum 50 °C

**Materials**Ceramic Al<sub>2</sub>O<sub>3</sub>, bubble point 500 kPa

Shaft PMMA

Sensor Unit PMMA and TPE

**Cable Length**

1.5 m

**Cable Diameter**

3.0 mm (0.12 in)

**Connector Types**

4-pin stereo plug connector

**Stereo Plug Connector Diameter**

3.50 mm

**Conductor Gauge**

31 AWG drain wire

**ELECTRICAL AND TIMING CHARACTERISTICS****Supply Voltage (VCC to GND)**

Minimum 3.6 V

Typical 12.0 V

Maximum 28.0 V

**Digital Input Voltage (logic high)**

Minimum 1.6 V

Typical 3.3 V

Maximum 5.0 V

**Digital Input Voltage (logic low)**

Minimum	-0.3 V
Typical	0.0 V
Maximum	0.9 V

**Digital Output Voltage (logic high)**

Minimum	NA
Typical	3.6 V
Maximum	NA

**Power Line Slew Rate**

Minimum	1.0 V/ms
Typical	NA
Maximum	NA

**Current Drain (during measurement)**

Minimum	18.0 mA
Typical	25.0 mA
Maximum	30.0 mA

**Current Drain (while asleep)**

Minimum	0.03 mA
Typical	0.05 mA
Maximum	0.90 mA

**Power Up Time (DDI Serial)**

Minimum	125 ms
Typical	130 ms
Maximum	150 ms

**Power Up Time (SDI-12)**

Minimum	125 ms
Typical	130 ms
Maximum	150 ms

**Power Up Time (SDI-12, DDI Serial disabled)**

Minimum	125 ms
Typical	130 ms
Maximum	150 ms

**Measurement Duration**

Minimum	60 ms
Typical	65 ms
Maximum	70 ms

**COMPLIANCE**

EM ISO/IEC 17050:2010 (CE Mark)

**3.2 COMPONENTS**

The TEROS 31 sensor measures soil water potential and temperature. Water potential is measured using a water-filled shaft with a porous ceramic tip at the end conducted to an absolute pressure transducer. Soil temperature is measured by the pressure transducer inside the sensor unit.

**NOTE:** If the sensor unit is not buried, measured temperature may diverge from soil temperature.

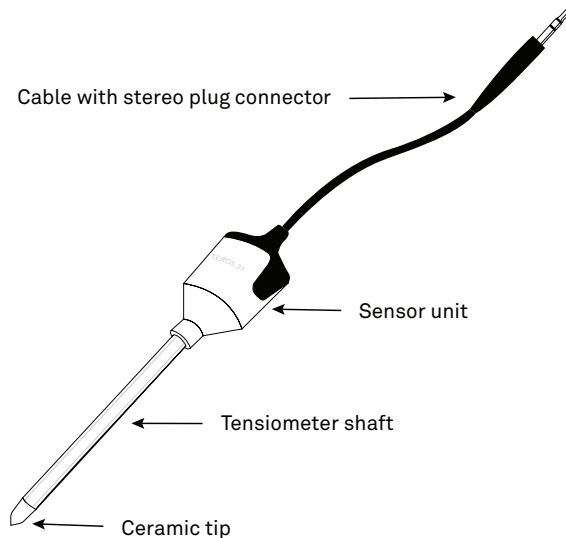

**Figure 10 TEROS 31 sensor**



TEROS 31 has a low power requirement, which makes it ideal for long-term burial in the soil. The sensor can be read continuously with a data logger or periodically with a handheld reader.

### 3.3 THEORY

The following sections explain the theory of soil water potential measurements.

#### 3.3.1 WATER POTENTIAL MEASUREMENTS

All soil water potential measurement techniques measure the potential energy of water in equilibrium with water in the soil. The Second Law of Thermodynamics states that connected systems with differing energy levels move toward an equilibrium energy level. When an object, such as the TEROS 31 ceramic tip, comes into hydraulic contact with the soil, the water potential of the object comes into equilibrium with the soil water potential. The water in the tensiometer shaft transmits the total potential from the soil water through the porous ceramic to the pressure transducer. The ceramic tip acts as a semipermeable diaphragm with a very high water conductivity. It is very important to get a good capillary contact to the surrounding soil.

Equation 2 gives the component variables for determining total soil water potential ( $\Psi_t$ ):

$$\Psi_t = \Psi_p + \Psi_g + \Psi_o + \Psi_m \quad \text{Equation 2}$$

where:

$\Psi_p$  is atmospheric pressure

$\Psi_g$  is gravitational potential

$\Psi_o$  is osmotic potential

$\Psi_m$  is matric potential

For TEROS 31 applications,  $\Psi_g$  is generally insignificant.  $\Psi_p$  should be measured by a reference sensor (Section 3.3.2).  $\Psi_o$  arises from dissolved salts in the soil and becomes important only if a semipermeable barrier is present that prevents ionic movement. The TEROS 31 ceramic tip has a pore size of  $r = 0.3 \mu\text{m}$  and cannot block ions, so the osmotic potential is negligible.  $\Psi_m$  arises from the attraction of water to the soil particles and is the most important component of water potential in most soils. TEROS 31 responds to the matric potential of the soil ( $\Psi_m$ ).

#### 3.3.2 BAROMETRIC COMPENSATION

TEROS 31 measures the sum of matric potential and atmospheric pressure potential ( $\Psi_p + \Psi_m$ ). To extract the matric potential, the barometric pressure should also be registered with a reference sensor. METER ZL6 and EM60 data loggers include a barometric pressure sensor and convert the signal into soil water potential. One atmospheric pressure sensor at every measuring site is enough to convert all TEROS 31 measurements at the site.

If using a non-METER data logger, a barometric sensor is needed at the measuring site. A barometric sensor is available from METER by contacting [Customer Support](#).

### 3.3.3 MEASUREMENT RANGE

The measuring range of tensiometers is limited by the boiling point of water. At a temperature of 20 °C, the boiling point is at 2.3 kPa over vacuum. So with 20 °C and an atmospheric pressure of 95 kPa the tensiometer cannot measure a tension below -92.7 kPa, even if the soil gets drier than that. The readings remain at a constant value (Figure 11, between day 10 and 16).

If the soil becomes drier and reaches -500 kPa, the ceramic air-entry point is reached. The water in the ceramic cup will dry out quickly, and the reading of the air-filled cup will drop to 0 kPa, even if soil gets drier (Figure 11, day 16 to 19).

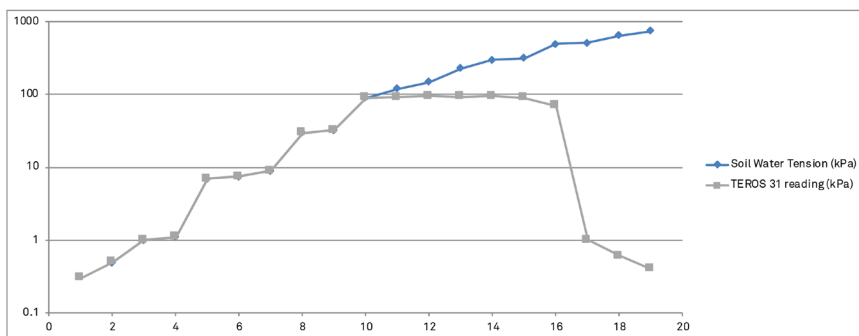

Figure 11 Tensiometer readings with tensions to -1,000 kPa

If there will be rain before the soil water potential reaches -500 kPa, the tensiometer tip will absorb the soil water. The soil water includes dissolved gas. If soil water potential increases, the dissolved gas will expand and will limit the measuring range. This will result in a slow response—the signal curve will get flatter, and the readings will slowly approach the actual soil water potential. Depending on the size of the developed bubble, readings will get further from the actual water potential (Figure 12, after day 20).

## TEROS 31

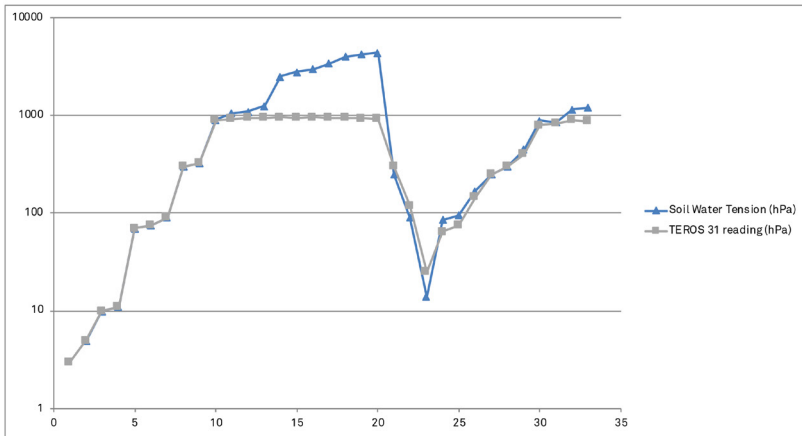

Figure 12 Tensiometer readings with tensions to  $-400$  kPa

If soil water tension rises higher than TEROS 31 measurement range (about  $-85$  kPa), a boiling retardation may occur (Figure 13). Properly filled TEROS 31 tensiometers are able to measure boiling retardation up to  $-250$  kPa. The TEROS 31 signal drops down to normal measurement range when boiling retardation collapses.

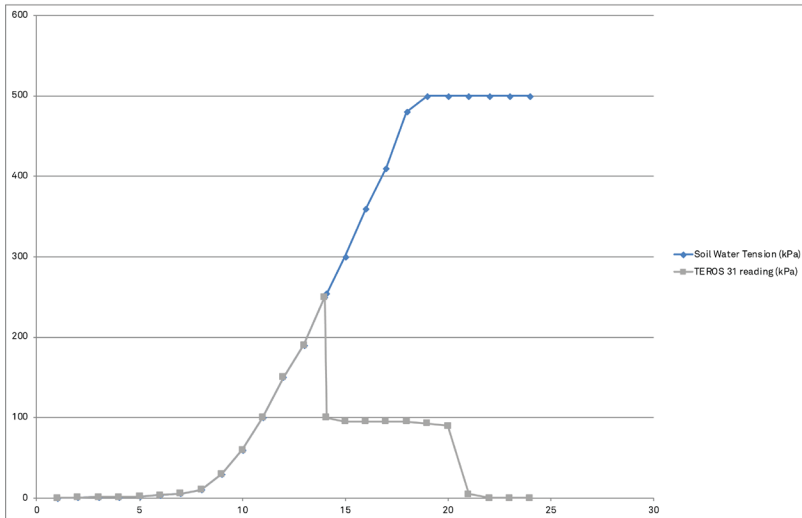

Figure 13 Tensiometer readings with boiling retardation

In saturated soils or measuring sites with perched water, the TEROS 31 will measure pressure potentials.

### **3.3.4 TEMPERATURE**

The TEROS 31 uses the integrated temperature sensor of the pressure transducer to take temperature readings. TEROS 31 measures soil temperature only if the sensor unit is buried in the soil. The TEROS 31 sensor output temperature is in degrees Celsius unless otherwise stated in the data logger program, such as in preferences in the ZENTRA software.

## 4. SERVICE

This section contains calibration and recalibration information, calibration frequencies, cleaning and maintenance guidelines, troubleshooting guidelines, customer support contact information, and terms and conditions.

### 4.1 CALIBRATION

METER software tools automatically apply factory calibrations to the sensor output data.

### 4.2 RECALIBRATION RECOMMENDATIONS

The TEROs 31 may be returned to METER for maintenance in the following areas: system inspection, parts replacement, and instrument cleaning. Replacement parts can also be ordered from METER. Contact [Customer Support](#) for more information.

The nominal lifespan for outdoor usage is 10 years, but the lifespan can be substantially extended by proper and careful usage and by protecting the sensor against UV radiation and frost.

Depending on the installation site, the TEROs 31 ceramic tip may dry out. To assure a rapid and reliable measurement of the soil water potential, the ceramic tip must be filled with deionised water after dry periods or periods with a large number of wet and drying out cycles ([Section 2.2](#)).

**NOTE:** Refilling is only reasonable if the soil is wetter than  $-85$  kPa after a dry period.

#### 4.2.1 CHECKING WATER POTENTIAL ACCURACY

If the water potential values seem incorrect, use the following steps to check the zero point of the TEROs 31 pressure transducer.

1. Unscrew the tensiometer shaft.
2. Remove all water from the sensor unit and place the sensor unit in a horizontal position.
3. Connect the TEROs 31 to a handheld reader or data logger and wait until the signal is stable.

The readings should be about  $0$  kPa  $\pm 0.3$  kPa (compensated value) or the actual barometric pressure of  $101.3$  kPa  $\pm 0.3$  kPa (uncompensated value).

#### 4.2.2 REPLACING THE O-RING INSIDE THE SENSOR UNIT

If water potential rises slowly or not at all even though the TEROs 31 is properly filled, the O-ring inside the sensor unit ([Figure 14](#)) may be worn out and needs to be replaced.

1. Unscrew the shaft from the sensor unit.
2. Use needle-nose or surgical tweezers to remove the old black O-ring ([Figure 14](#)).

**NOTE:** Do not puncture the pressure sensor hole or the pressure sensor will be damaged.

3. Carefully insert the new O-ring into the sensor unit.

4. Screw the shaft securely back onto the sensor unit.

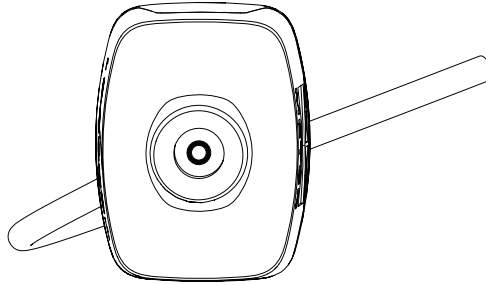

Figure 14 O-ring inside sensor unit

### 4.2.3 OFFSET CORRECTION

The shaft acts as a hanging water column (Figure 15). An integrated orientation sensor compensates for the arising offset due to the hanging water column.

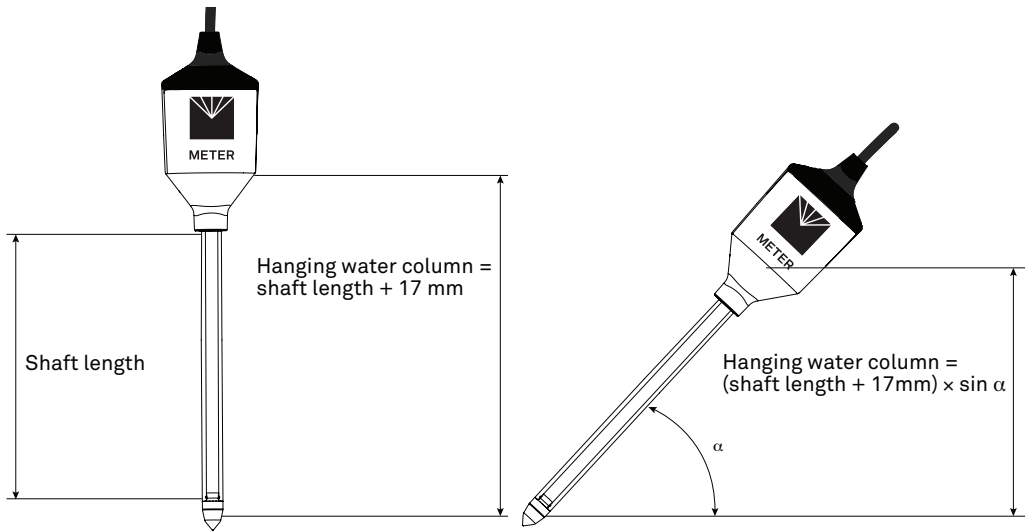

Figure 15 Position of reference point for water potential measurement

The shaft length of the TEROS 31 is already registered in the sensor settings. If the shaft length changes, the settings have to be adjusted to the new length. Use the following steps to set the new shaft length:

1. Connect the TEROS 31 to a ZL6 data logger.
2. Open ZENTRA Utility software.
3. Open the Digital Sensor Terminal (Figure 16).

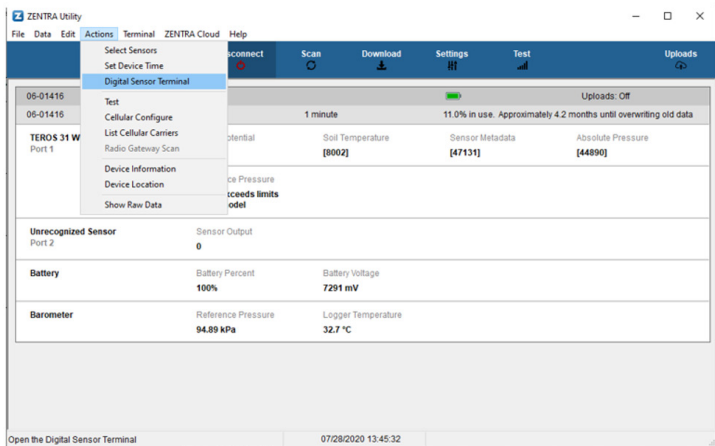

Figure 16 Open Digital Sensor Terminal in ZENTRA Utility

- Select the required sensor port and send the shaft length command `XS<value>!` (replace `<value>` with the shaft length between 0 and 20 cm) (Figure 17).

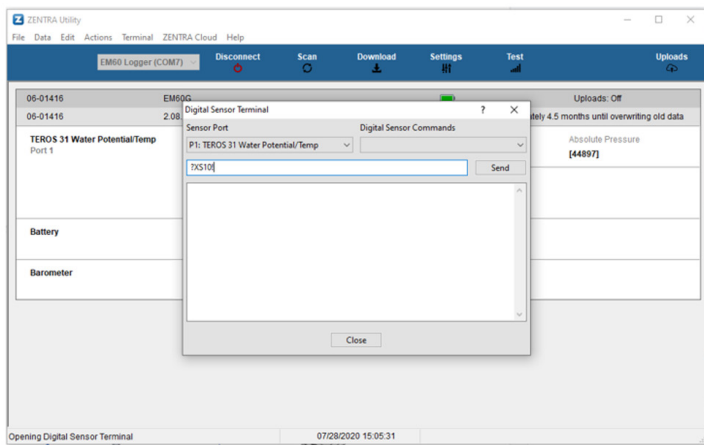

Figure 17 Send shaft length command to TEROS 31

- To read out the current shaft length setting, send the command: `?XS!`

For non-METER data logger,

- Connect the TEROS 31 to a SDI-12 channel.
- Open a terminal program.
- Send shaft length command `aXS<value>!` (replace `a` with the SDI-12 sensor address and `<value>` with the shaft length between 0 and 20 cm).
- To read out the current shaft length setting, send the command `aXS!`.

The TEROS 31 orientation sensor identifies the installation angle and calculates the required offset correction. The sensor output is always adjusted to the offset. If the shaft length changes, the new length must be entered into the sensor settings.

#### 4.2.4 CLEANING

The TEROS 31 shaft is made of acrylic and should be cleaned using only water. Acrylic is susceptible to alcohol and other solvents.

Use only water to clean the ceramic tip. Use of tenside or any other cleaner will make the ceramic unusable! Exposure to oils or other hydrophobic substances compromises the ability of the ceramic tip to get capillary contact to the soil. This inability to get capillary contact leads to slow equilibration times and loss of accuracy. Minimize exposure of the ceramic material to skin oils, grease, synthetic oils, or other hydrophobic compounds.

### 4.3 TROUBLESHOOTING

[Table 4](#) lists common problems and their solutions. Most issues with the TEROS 31 sensor will manifest themselves in the form of incorrect or erroneous readings. If the problem is not listed or these solutions do not solve the issue, contact [Customer Support](#).

**Table 4 Troubleshooting the TEROS 31**

Problem	Possible Solutions
<b>Data logger is not recognizing sensor</b>	<p>If using a METER logger, update logger firmware.</p> <p>Check the logger configuration for a non-METER data logger using its user manual.</p> <p>Check power to the sensor.</p>
<b>Data logger is not receiving readings from the sensor</b>	<p>Check that the connections to the data logger are both correct and secure.</p> <p>Ensure that data logger batteries are not dead or weak.</p> <p>Check configuration of data logger through software to ensure TEROS 31 is selected.</p> <p>Ensure the software and firmware is up to date.</p>
<b>Sensor is not responding</b>	<p>Check power to the sensor.</p> <p>Check sensor cable and connector integrity.</p> <p>Check data logger wiring is correct (<a href="#">Section 2.3</a>).</p>
<b>Matric potential signal steps up and down</b>	<p>Check capillary contact to the soil.</p> <p>Check connection at data logger plug.</p> <p>Check cable insulation.</p>



Table 4 Troubleshooting the TEROS 31 (continued)

Problem	Possible Solutions
<b>Matric potential signal does not increase even when soil is getting dry</b>	Refill TEROS 31 ceramic with deionised water ( <a href="#">Section 2.2</a> ).
	Check if the shaft is properly screwed into the sensor unit.
	Check if the O-ring inside the sensor unit is worn out ( <a href="#">Section 4.2.2</a> ).
<b>Cable or connector failure</b>	If a stereo plug connector is damaged or needs to be replaced, contact <a href="#">Customer Support</a> for a replacement connector and splice kit.

## 4.4 CUSTOMER SUPPORT

### NORTH AMERICA

Customer service representatives are available for questions, problems, or feedback Monday through Friday, 7:00 am to 5:00 pm Pacific time.

**Email:** [support.environment@metergroup.com](mailto:support.environment@metergroup.com)  
[sales.environment@metergroup.com](mailto:sales.environment@metergroup.com)

**Phone:** +1.509.332.5600

**Fax:** +1.509.332.5158

**Website:** [metergroup.com](http://metergroup.com)

### EUROPE

Customer service representatives are available for questions, problems, or feedback Monday through Friday, 8:00 to 17:00 Central European time.

**Email:** [support.europe@metergroup.com](mailto:support.europe@metergroup.com)  
[sales.europe@metergroup.com](mailto:sales.europe@metergroup.com)

**Phone:** +49 89 12 66 52 0

**Fax:** +49 89 12 66 52 20

**Website:** [metergroup.de](http://metergroup.de)

If contacting METER by email, please include the following information:

Name	Email address
Address	Instrument serial number
Phone	Description of the problem

**NOTE:** For products purchased through a distributor, please contact the distributor directly for assistance.

## 4.5 TERMS AND CONDITIONS

By using METER instruments and documentation, you agree to abide by the METER Group, Inc. Terms and Conditions. Please refer to [metergroup.com/terms-conditions](https://metergroup.com/terms-conditions) for details.

# INDEX

## A

accuracy 17  
 auger 2, 3, 5, 6, 9

## B

barometric reference sensor 2, 21–22

## C

cable length 18  
 calibration 25  
 cleaning 28  
 compliance 20  
 components  
   ceramic tip 2, 9, 20  
   o-ring 25–26  
   pressure transducer 20, 25  
   reference point 6  
   sensor unit 9, 20  
   tensiometer shaft 9, 20

connecting  
   METER logger 13  
   non-METER logger 13–15  
 connector types 18  
 customer support 29

## E

email address 29

## F

fax number 29

## I

installation  
   angle 8  
   filling 3, 9–12  
   methods 5–6  
   tools required 2

## L

lifespan 25

## M

measurements 17, 21, 22–23

## O

offset correction 26–28

## P

phone number 29

## R

range 17  
 refilling 2, 9–12  
 refill syringe 3  
 refill unit 1, 9, 11

## S

specifications 17–20  
   communication 17  
   data logger compatibility 17  
   electrical and timing characteristics  
     18–20  
   measurement 17  
   physical 17–18

## T

temperature 17, 18, 24  
 terms and conditions 30  
 theory 21–23  
 troubleshooting 28–29

## W

water potential 1, 2, 25  
 wiring 14, 14–15

**Z**

ZENTRA

ZENTRA Cloud **13**

ZENTRA Utility **13**

**METER Group, Inc.**

2365 NE Hopkins Court Pullman, WA 99163  
T: +1.509.332.2756 F: +1.509.332.5158  
E: info@metergroup.com W: metergroup.com

**METER Group GmbH**

Mettlacher Straße 8, 81379 München  
T: +49 89 1266520 F: +49 89 12665220  
E: info.europe@metergroup.com W: metergroup.de

