

TABLE OF CONTENTS

1. Introduction.....	1
2. Operation	2
2.1 Installation	2
2.2 Connecting.....	3
2.2.1 Connect to METER Logger	4
2.2.2 Connect to Non-METER Logger	4
2.3 Communication	6
3. System.....	7
3.1 Specifications.....	7
3.2 Components	10
3.3 Theory.....	10
3.3.1 Water Potential Measurement	10
3.3.2 Measurement Range	11
3.3.3 Measurement Accuracy	12
3.3.4 Temperature Measurement.....	13
3.4 Considerations.....	13
3.4.1 Measuring in Frozen Soils	13
3.4.2 Measuring in High Salinity	13
3.4.3 Temperature Sensitivity.....	14
4. Service.....	15
4.1 Calibration	15
4.2 Maintenance.....	15
4.3 Troubleshooting.....	16

4.4 Customer Support..... 16
4.5 Terms and Conditions 17

References 18

Index 19

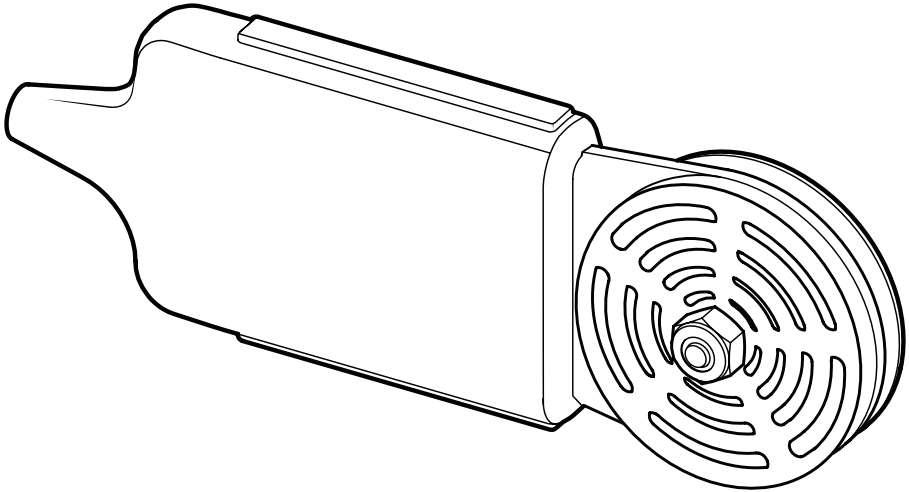

1. INTRODUCTION

Thank you for purchasing the TEROS 21 Soil Water Potential Sensor from METER Group.

TEROS 21 was designed to be a maintenance-free matric potential sensor designed for long-term, continuous field measurements. The TEROS 21 measures the dielectric permittivity of a solid matrix to determine the water content of the solid matrix. The relationship between water content and matric potential, known as the soil moisture characteristic curve, is used to calculate the soil matric potential. This measurement approach, along with the calibration process used in production, allows for accurate measurements of water potential.

Prior to use, verify the TEROS 21 arrived in good condition.

2. OPERATION

Please read all instructions before operating the TEROS 21 to ensure it performs to its full potential.

PRECAUTIONS

METER sensors are built to the highest standards, but misuse, improper protection, or improper installation may damage the sensor and possibly void the manufacturer's warranty. Before integrating TEROS 21 into a system, follow the recommended installation instructions and have the proper protections in place to safeguard sensors from damage.

2.1 INSTALLATION

Follow the steps listed in [Table 1](#) to set up the sensor. It is critical that the sensor has good hydraulic contact with the soil to make accurate measurements.

Table 1 Installation

Tools Needed	<p>Auger or shovel</p> <p>Secure mounting location for data logger and cable</p> <p>Knife (if installing in shallow depth)</p> <p>Water (for packing soil or making slurry)</p>
Preparation	<p>Conduct System Check</p> <p>Plug the sensor into the logger (Section 2.2) to make sure the sensor is functional.</p>
Installation	<p>Create Hole</p> <p>Avoid interfering objects.</p> <p>Auger or trench a hole to the desired sensor depth.</p> <p>Pack Sensor</p> <p>Moisten native soil and pack it firmly around the entire sensor discs. Ensure the soil is in contact with all surfaces of the ceramic.</p> <p>NOTE: Sandy soils may not adhere to the sensor even when wet. If so, place the sensor at the bottom of the hole and carefully pack the soil around the sensor. Be sure to pack the soil firmly around ceramic surfaces.</p> 

Table 1 Installation (continued)

Installation (continued)	Insert Sensor
	For shallow installation (less than ~30 cm), use a knife to remove a small sliver of soil. Insert packed sensor into the channel.
	For deep installation (greater than ~30 cm), use the native soil to make a slurry with water. Lower sensor into the hole and fill with the slurry.
	NOTE: Soils with high shrink-swell potential may pull away from the sensor as they dry and disrupt measurements.
	NOTE: Do not install the sensor with the body exposed above ground.
	Secure and Protect Cables
	NOTE: Improperly protected cables can lead to severed cables or disconnected sensors. Cabling issues can be caused by many factors such as rodent damage, driving over sensor cables, tripping over cables, not leaving enough cable slack during installation, or poor sensor wiring connections.
	Install cables in conduit or plastic cladding when near the ground to avoid rodent damage.
	Leave at least 15 cm (6 in) of sensor cable beneath the soil before bringing the cable to the surface. At least 10 cm (4 in) of cable should exit the sensor body in a straight line before bending the cable.
	Gather and secure cables between the TEROS 21 and the data logger to the mounting mast in one or more places.
Connect to Logger	
Plug the sensor into a data logger.	
Use the data logger to make sure the sensor is reading properly.	
Verify that these readings are within expected ranges.	
For more instructions on connecting to data loggers, refer to Section 2.2 .	
Backfill the Hole	
Return soil to the hole, packing the soil back to its native bulk density.	

2.2 CONNECTING

The TEROS 21 works seamlessly with METER data loggers. The TEROS 21 can also be used with other data loggers, such as those from Campbell Scientific, Inc. For extensive directions on how to integrate the sensors into third-party loggers, refer to the [TEROS 21 Integrator Guide](#).

TEROS 21 sensors require an excitation voltage in the range of 3.6 to 15 VDC and operate at a 3.6-VDC level for data communication. TEROS 21 can be integrated using SDI-12 protocol. See the [TEROS 21 Integrator Guide](#) for details on interfacing with data acquisition systems.

TEROS 21 sensors comes with a 3.5-mm stereo plug connector ([Figure 1](#)) to facilitate easy connection with METER loggers. TEROS 21 sensors may be ordered with stripped and tinned wires to facilitate connecting to some third-party loggers ([Section 2.2.2](#)).

TEROS 21

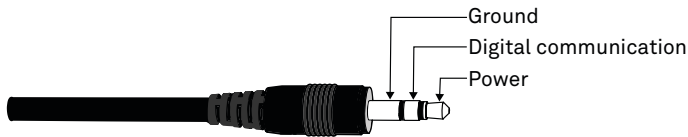

Figure 1 3.5-mm stereo plug connector

The TEROS 21 sensor comes standard with a 5-m cable. It may be purchased with custom cable lengths for an additional fee (on a per-meter basis). In some instances, the cable can be extended beyond 75 m by the user, but this is discouraged for a variety of reasons. Please contact Customer Support for more details before extending or splicing cables.

2.2.1 CONNECT TO METER LOGGER

The TEROS 21 works most efficiently with METER ZENTRA series data loggers. Check the METER download webpage for the most recent data logger firmware. Logger configuration may be done using either ZENTRA Utility (desktop and mobile application) or ZENTRA Cloud (web-based application for cell-enabled ZENTRA data loggers).

1. Plug the stereo plug connector into one of the sensor ports on the logger.
2. Use the appropriate software application to configure the chosen logger port for the TEROS 21. METER data loggers will automatically recognize TEROS 21 sensors.
3. Set the measurement interval.

METER data loggers measure the TEROS 21 every minute and return the minute-average data across the chosen measurement interval.

TEROS 21 data can be downloaded from METER data loggers using either ZENTRA Utility or ZENTRA Cloud. Refer to the logger user manual for more information about these programs.

2.2.2 CONNECT TO NON-METER LOGGER

The TEROS 21 can be purchased for use with non-METER (third party) data loggers. Refer to the third-party logger manual for details on logger communications, power supply, and ground ports. The [TEROS 21 Integrator Guide](#) provides detailed instructions on connecting sensors to non-METER loggers.

TEROS 21 sensors can be ordered with stripped and tinned (pigtail) connecting wires for use with screw terminals. Refer to the third-party logger manual for details on wiring.

Connect the TEROS 21 wires to the data logger illustrated in [Figure 2](#) and [Figure 3](#), with the supply wire (brown) connected to the excitation, the digital out wire (orange) to a digital input, and the bare ground wire to ground.

OPERATION

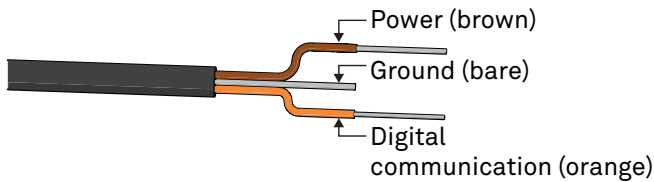

Figure 2 Pigtail wiring

NOTE: Sensors manufactured as MPS-6 use white wire for power and red wire for data output.

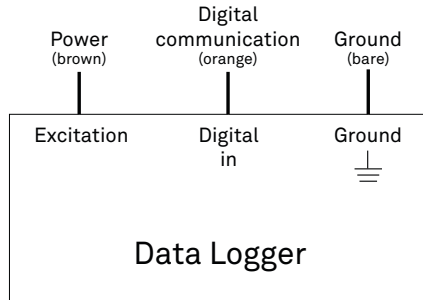

Figure 3 Wiring diagram

NOTE: The acceptable range of excitation voltages is from 3.6 to 15 VDC.

If the TEROS 21 cable has a standard stereo plug connector and needs to be connected to a non-METER data logger, use one of the following two options.

Option 1

1. Clip off the stereo plug connector on the sensor cable.
2. Strip and tin the wires.
3. Wire it directly into the data logger.

This option has the advantage of creating a direct connection and minimizes the chance of the sensor becoming unplugged. However, it then cannot be easily used in the future with a METER readout unit or data logger.

Option 2

Obtain an adapter cable from METER.

The adapter cable has a connector for the stereo plug connector on one end and three wires (or pigtail adapter) for connection to a data logger on the other end. The stripped and tinned adapter cable wires have the same termination as in [Figure 3](#): the brown wire is excitation, the orange is output, and the bare wire is ground.

NOTE: Secure the stereo plug connector to the pigtail adapter connections using adhesive-line heat shrink to ensure the sensor does not become disconnected during use.

2.3 COMMUNICATION

The SDI-12 protocol requires that all sensors have a unique address. TEROS 21 sensors factory default is an SDI-12 address of 0. To add more than one SDI-12 sensor to a bus, the sensor address must be changed as described below:

1. Using a ProCheck connected to the sensor, press the **Menu** button to bring up the CONFIG menu.

NOTE: If the ProCheck does not have this option, please upgrade its firmware to the latest version from the [METER Legacy Handheld Devices webpage](#).

2. Scroll down to SDI-12 Address. Press **Enter**.
3. Press the **UP** or **DOWN** arrows until the desired address is highlighted.
Address options include 0...9, A...Z, and a...z.
4. Press **Enter**.

Detailed information can also be found in the application note [Setting SDI-12 addresses on METER digital sensors using Campbell Scientific data loggers and LoggerNet](#).

When using the sensor as part of an SDI-12 bus, excite the sensors continuously to avoid issues with initial sensor startup interfering with the SDI-12 communications.

3. SYSTEM

This section reviews the components and functionality of the TEROS 21 sensor.

3.1 SPECIFICATIONS

MEASUREMENT SPECIFICATIONS

Water Potential

Range –9 to –2,000 kPa (1.96 to 4.31 pF)

Resolution 0.1 kPa

Accuracy ±(10% of reading + 2 kPa) from –100 to –9 kPa

NOTE: TEROS 21 is not well calibrated beyond –100 kPa. For more information on using the TEROS 21 beyond this range, see [Section 3.3.3](#).

NOTE: TEROS 21 sensors with serial numbers up to T21-00009999 have a water potential range of –9 to –100,000 kPa.

Dielectric Measurement Frequency

70 MHz

Temperature

Range –40 to +60 °C

Resolution 0.1 °C

Accuracy ±1 °C

COMMUNICATION SPECIFICATIONS

Output

RS-232 (TTL) with 3.6-V or SDI-12 communication protocol

Data Logger Compatibility

METER ZL6, EM60, and Em50 data loggers or any data acquisition system capable of 3.6- to 15-VDC power and serial or SDI-12 communication

PHYSICAL SPECIFICATIONS

Dimensions

Length 9.6 cm (3.8 in)

Width 3.5 cm (1.4 in)

Height 1.5 cm (0.6 in)

Sensor Diameter

3.2 cm (1.3 in)

Operating Temperature Range

Minimum -40 °C

Typical NA

Maximum +60 °C

NOTE: Sensors may be used at higher temperatures under certain conditions; contact [Customer Support](#) for assistance.

Cable Length

5 m (standard)

75 m (maximum custom cable length)

NOTE: Contact [Customer Support](#) if a nonstandard cable length is needed.

Connector Types

3.5-mm stereo plug connector or stripped and tinned wires

ELECTRICAL AND TIMING SPECIFICATIONS**Supply Voltage (VCC to GND)**

Minimum 3.6 VDC

Typical NA

Maximum 15.0 VDC

Digital Input Voltage (logic high)

Minimum 2.8 V

Typical 3.6 V

Maximum 3.9 V

Digital Input Voltage (logic low)

Minimum -0.3 V

Typical 0.0 V

Maximum 0.8 V

SYSTEM

Power Line Slew Rate

Minimum	1.0 V/ms
Typical	NA
Maximum	NA

Current Drain (during measurement)

Minimum	3.0 mA
Typical	3.6 mA
Maximum	10.0 mA

Current Drain (while asleep)

Minimum	NA
Typical	0.03 mA
Maximum	NA

Power-Up Time (DDI serial)

Minimum	NA
Typical	NA
Maximum	100 ms

Power-Up Time (SDI-12)

Minimum	100 ms
Typical	150 ms
Maximum	200 ms

Measurement Duration

Minimum	NA
Typical	150 ms
Maximum	200 ms

COMPLIANCE

Manufactured under ISO 9001:2015

EM ISO/IEC 17050:2010 (CE Mark)

3.2 COMPONENTS

The TEROS 21 sensor measures the water potential and temperature of soil with porous ceramic discs (Figure 4). TEROS 21 sensors measure moisture content changes of two engineered ceramic discs sandwiched between stainless steel screens and the circuit board. These sensors have a low power requirement, which makes them ideal for permanent burial in the soil and continuous reading with a data logger or periodic reading with a handheld reader.

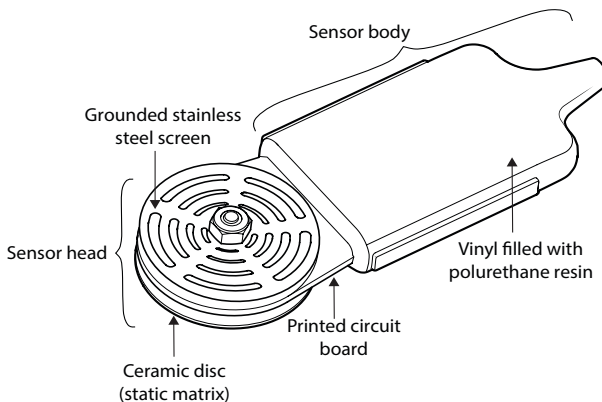

Figure 4 TEROS 21 sensor

3.3 THEORY

TEROS 21 sensors measure water potential, so they are not as sensitive to soil disturbance as water content sensors. TEROS 21 need good hydraulic contact with the surrounding soil for accurate measurements.

3.3.1 WATER POTENTIAL MEASUREMENT

All soil water potential measurement techniques measure the potential energy of water in equilibrium with water in the soil. The Second Law of Thermodynamics states that connected systems with differing energy levels move toward an equilibrium energy level. When an object comes into hydraulic contact with the soil, the water potential of the object comes into equilibrium with the soil water potential.

TEROS 21 uses a solid matrix equilibration technique to measure the water potential of the soil. This technique introduces a material with a known pore size distribution into the soil and allows it to come into hydraulic equilibrium according to the Second Law of Thermodynamics. Because the two are in equilibrium, measuring the water potential of the solid matrix gives the water potential of the soil.

TEROS 21 measures the dielectric permittivity of a solid matrix (porous ceramic discs) to determine its water potential. The dielectric permittivity of air, the solid ceramic, and water are 1, 5, and 80, respectively. So, the dielectric permittivity of the porous

ceramic discs is highly dependent on the amount of water present in the pore spaces. Measuring the dielectric permittivity of the ceramic discs resolves a wide range of water content measurements.

Water content and water potential are related by a relationship unique to a given material, called the moisture characteristic curve. The ceramic used with the TEROS 21 has a wide pore size distribution and is consistent between discs, giving each disc the same moisture characteristic curve. Thus, the water potential can be inferred from water content using the moisture characteristic curve of the ceramic

Equation 1 gives the component variables for determining total soil water potential (Ψ_t):

$$\Psi_t = \psi_p + \psi_g + \psi_o + \psi_m \quad \text{Equation 1}$$

where Ψ_p is pressure, Ψ_g is gravitational, Ψ_o is osmotic, and Ψ_m is matric.

For TEROS 21 applications, Ψ_p and Ψ_g are generally insignificant. Ψ_o arises from dissolved salts in the soil and only becomes important if a semipermeable barrier is present that prevents ionic movement (e.g., plant roots or cell membranes). Ψ_m arises from the attraction of water to the soil particles and is the most important component of water potential in most soils. TEROS 21 responds to the matric potential of the soil (Ψ_m). In highly salt-affected soils, it may be necessary to quantify Ψ_o independently if the measurements of soil water potential are related to biological activity (Section 3.4.2).

3.3.2 MEASUREMENT RANGE

TEROS 21 measures the water content of porous ceramic discs and converts the measured water content to water potential using the moisture characteristic curve of the ceramic. Therefore, it is important that the ceramic discs drain over a wide water potential range. Pore size determines the water potential at which a pore drains (the air entry potential or bubble pressure), so the ideal ceramic would have pores that range from very small to relatively large. METER designed the ceramic discs to approach this ideal. The discs have a total pore volume that is weighted toward the larger pores, which drain at water potentials within the plant-available range (approximately -33 to -2,000 kPa).

DRY-END LIMITATIONS

As the sensor dries past the plant-available range, the total pore volume that drains at a given water potential decreases. At these low water potentials, the measured water potential can become somewhat noisy because small changes in measured water content of the ceramic translate into large changes in water potential. This phenomenon is most pronounced when the sensor is air dry. It is expected that the measured water potential of a dry sensor open to the air can jump around significantly. The noise level is much lower when the sensor is installed in the soil, even at air-dry water potential.

NOTE: Water potentials below -2,000 kPa exceed the detection limits of the TEROS 21. When water potential is below -2,000 kPa the TEROS 21 will report an error code (-9990) and an error message will appear (Sensor value is temporarily out of range).

WET-END LIMITATIONS

The air entry potential of the largest pores in the ceramic is about -9 kPa. However, the ceramic disc must have access to air for the large pores to begin draining and the response of the sensor to change. If the soil around the sensor has an air entry potential lower (drier) than -9 kPa, the ceramic will not begin to lose water until reaching the air entry potential of the soil. In this scenario, the air entry potential of the soil limits the wet-end range, rather than the ceramic discs themselves. The sensor may not begin to respond until lower water potentials. This is generally only an issue when using the sensor in poorly structured soils with high clay content.

3.3.3 MEASUREMENT ACCURACY

TEROS 21 is calibrated at a saturated state (0 kPa), at a dry state equivalent to $(-2,000$ kPa), and at four calibration points between 0 and -100 kPa, resulting in accuracy of $\pm(10\%$ of reading + 2 kPa) over the range of -9 to -100 kPa.

At water potentials drier than -100 kPa, TEROS 21 relies on the linear relationship between the logarithm of water content and the logarithm of water potential. Laboratory evaluations have shown good accuracy to at least $-1,500$ kPa (plant permanent wilting point). Independent field evaluations have also shown low sensor-to-sensor variability down to permanent wilting point (Figure 5).

NOTE: METER strongly discourages dry-end calibrations of the TEROS 21 in the pressure plate apparatus. Early attempts to improve sensor dry-end performance in the pressure plate apparatus actually decreased accuracy, likely because of pressure plate dry-end equilibrium issues pointed out in the literature (e.g., Campbell [1998], Gee et al. [2002], Bittelli and Flury [2009], and Frydman and Baker [2009]).

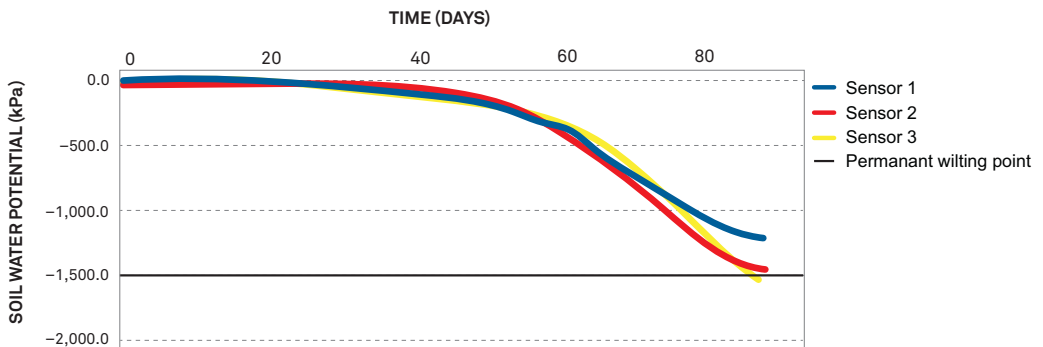

Figure 5 Time series TEROS 21 water potential data collected at 80 cm depth under a beech forest in Switzerland (Walthert, 2013). Note the good sensor agreement down to permanent wilting point ($-1,500$ kPa).

3.3.4 TEMPERATURE MEASUREMENT

TEROS 21 uses a surface-mounted thermistor to take temperature readings. The thermistor is located underneath the sensor epoxy. The TEROS 21 output temperature readings in degrees Celsius unless otherwise stated in preference settings in METER software programs. If the black plastic body of the sensor is exposed to solar radiation, the temperature measurement may read high. Exposure of the body also drastically decreases the life expectancy of the sensor. Do not install the sensor with the body above ground.

3.4 CONSIDERATIONS

TEROS 21 sensors use similar technology to METER water content sensors and are susceptible to the same constraints. Using TEROS 21 in certain environments will require additional considerations.

3.4.1 MEASURING IN FROZEN SOILS

TEROS 21 measures the dielectric permittivity of two ceramic discs to measure their water content and then derive their water potential. The dielectric permittivity of water in the ceramic discs is 80 compared to a dielectric permittivity of ~5 for the ceramic material or 1 for air. When water freezes to ice, the dielectric permittivity drops to 5 at the frequency of the sensor measurement, meaning that the sensor can no longer accurately measure the water in the ceramic. TEROS 21 does not accurately measure water potential in frozen soil conditions. However, the water potential of the soil under frozen soil conditions can be estimated by measuring the soil temperature accurately (Koopmans and Miller, 1966). For each 1 °C decrease in temperature below 0 °C, the water potential in the soil decreases by ~1,200 kPa. Spaans and Baker (1996) showed that this relationship is valid in field soils for water potentials below about -50 kPa.

Rigorous testing indicates that repeated freeze-thaw cycles do not affect the ceramic discs. Several sensors were equilibrated in saturated soil and then subjected to numerous freeze-thaw cycles in a temperature-controlled chamber. The freezing rate of the soil containers was at least an order of magnitude faster than could be achieved in field soils under natural conditions. At several points during the test, and at the end of the test, the ceramic discs were evaluated for damage due to repeated rapid freezing of pore spaces full of water. None of the ceramic discs showed any signs of physical damage, and none of the sensors showed any significant change in output due to the freeze-thaw tests.

3.4.2 MEASURING IN HIGH SALINITY

A saturation extract electrical conductivity (EC) greater than 10 dS/m will confound the capacitance measurement taken by the sensor resulting in erroneous matric potential readings. It is recommend that the TEROS 21 only be used in environments where the saturation extract EC does not exceed 10 dS/m.

3.4.3 TEMPERATURE SENSITIVITY

Fluctuations in temperature can affect the capacitance readings at matric potential less than about -500 kPa (Figure 6). Although temperature can affect the output of the reading, the nature of the moisture retention curve of the ceramic results in an extremely small effect on matric potential until the substrate dries out to about -500 kPa. A small change in water content can result in a relatively large change in matric potential beyond -500 kPa.

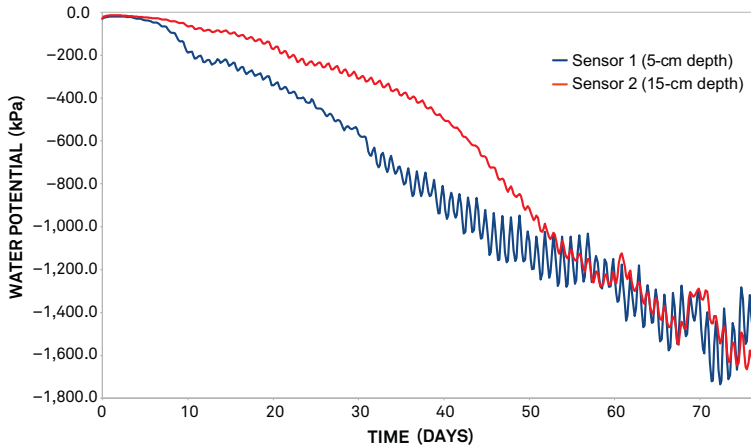

Figure 6 Temperature sensitivity data for TEROS 21 sensors

4. SERVICE

This section describes the calibration and maintenance of TEROS 21. Troubleshooting solutions and customer service information are also provided.

4.1 CALIBRATION

TEROS 21 calibration is not affected by soil type because the sensors only measure the water potential of the ceramic discs in equilibrium with the soil. TEROS 21 works in any soil type or other porous media as long as it is installed correctly with adequate hydraulic contact (to ensure timely water potential equilibrium between the sensor and the medium of interest).

The amount of water that a soil holds at a given water potential is greater if the material is dried to that water potential than if the material is wet up to that water potential; a phenomenon known as hysteresis. Because TEROS 21 essentially makes a dielectric measurement of water content and converts that to water potential, sensor measurements have some hysteresis. In most situations, soil undergoes brief periods of wet up (precipitation or irrigation events) followed by longer dry down periods, where water potential measurements are most useful. METER performs TEROS 21 calibration on the drying leg of the hysteresis loop, so the measurements are most accurate as the soil dries. Measurements as the soil wets up are slightly drier (more negative water potential) than the true water potential of the soil. METER wetting and drying tests show the magnitude of the hysteresis error is <10 kPa in the -20 to -100 kPa range.

4.2 MAINTENANCE

TEROS 21 may be returned to METER for maintenance in the following areas: system inspection, parts replacement, and instrument cleaning. Replacement parts can also be ordered from METER. Contact [Customer Support](#) for more information.

The ceramic discs are brittle and can chip or crack if abused. The metal screens afford the discs some amount of protection, but sharp trauma on the disc edges or massive impact (such as dropping the sensor onto a hard surface) can cause the ceramic to break. One or two small chips on the edge of the disc do not affect the sensor accuracy significantly. However, a cracked ceramic disc results in a loss of accuracy.

For TEROS 21 to accurately measure water potential, the ceramic discs must readily take up water. Exposure to oils or other hydrophobic substances compromises the ability of the discs to take up water from the soil. This inability to take up water leads to slow equilibration times and loss of accuracy. Minimize exposure of the ceramic material to skin oils, grease, synthetic oils, or other hydrophobic compounds.

4.3 TROUBLESHOOTING

Table 2 lists common problems and their solutions. Most issues with the TEROS 21 sensor will manifest themselves in the form of incorrect or erroneous readings. If the problem is not listed or these solutions do not solve the issue, contact [Customer Support](#).

Table 2 Troubleshooting TEROS 21

Problem	Possible Solutions
Data logger is not recognizing sensor	If using a METER logger, update logger firmware.
Data logger is not receiving readings from the sensor	<p>Check to make sure the connections to the data logger are both correct and secure.</p> <p>Ensure that your data logger batteries are not dead or weakened.</p> <p>Check configuration of data logger through software to ensure TEROS 21 is selected.</p> <p>Ensure the software and firmware is up to date.</p>
Sensor does not appear to be responding to changes in soil water potential	<p>Ensure that sensors are installed correctly.</p> <p>Check sensor cables for damage that could cause a malfunction.</p> <p>Check the ceramic disc for damage or contamination.</p>
Sensor reports error code -9990 or error message Sensor value is temporarily out of range	Water potential conditions are below -2,000 kPa (outside of the TEROS 21 effective measuring range). When the soil becomes wet again, the sensor should return to its normal measurements.

4.4 CUSTOMER SUPPORT

NORTH AMERICA

Customer service representatives are available for questions, problems, or feedback Monday through Friday, 7:00 am to 5:00 pm Pacific time.

Email: support.environment@metergroup.com
sales.environment@metergroup.com

Phone: +1.509.332.5600

Fax: +1.509.332.5158

Website: metergroup.com

SERVICE

EUROPE

Customer service representatives are available for questions, problems, or feedback Monday through Friday, 8:00 to 17:00 Central European time.

Email: support.europe@metergroup.com
sales.europe@metergroup.com

Phone: +49 89 12 66 52 0

Fax: +49 89 12 66 52 20

Website: metergroup.de

If contacting METER by email, please include the following information:

Name	Email address
Address	Instrument serial number
Phone	Description of the problem

NOTE: For products purchased through a distributor, please contact the distributor directly for assistance.

4.5 TERMS AND CONDITIONS

By using METER instruments and documentation, you agree to abide by the METER Group, Inc. USA Terms and Conditions. Please refer to metergroup.com/terms-conditions for details.

REFERENCES

- Bittelli, Marco and Markus Flury. 2009. Errors in Water Retention Curves Determined with Pressure Plates. *Soil Science Society of America Journal*. 73:1453–1460.
- Campbell, Gaylon S. 1988. Soil Water Potential Measurement: An Overview. *Irrigation Science*. 9:265–273.
- Frydman, S. and R. Baker. 2009. Theoretical Soil–Water Characteristic Curves Based on Adsorption, Cavitation, and a Double Porosity Model. *International Journal of Geomechanics*. 9(6):250–257.
- Gee, Glendon W., Andy L. Ward, Zhuanfang F. Zhang, Gaylon S. Campbell, and Jon B. Mathison. 2002. The Influence of Hydraulic Nonequilibrium on Pressure Plate Data. *Vadose Zone Journal*. 1:172–178.
- Koopmans, R.W.R. and R.D. Miller. 1966. Soil Freezing and Soil Water Characteristic Curves1. *Soil Science Society of America Journal*. 30:680–685.
- Spaans, Egbert J.A. and John M. Baker. 1996. The Soil Freezing Characteristic: Its Measurement and Similarity to the Soil Moisture Characteristic. *Soil Science Society of America Journal*. 60:13–19.
- Walthert, Lorenz. 2013. Soil as a Site Factor in Swiss Forests (project title). Swiss Federal Institute for Forest, Snow, and Landscape WSL Research.

INDEX

- C**
- cable colors 5
 - calibration 12, 15
 - ceramic pore size 13–14
 - cleaning. *See* maintenance
 - components
 - ceramic discs 10, 11–12, 15, 16
 - circuit board 10
 - screens 10, 15
 - sensor body 3, 10, 13
 - connecting 3–6, 16
 - customer support 16
- E**
- electrical conductivity 13
 - email address 16, 17
- F**
- fax number 16, 17
- H**
- hydraulic equilibrium 10, 15
 - hysteresis 15
- I**
- installation 2–3, 13
 - connecting 3–6
 - tools needed 2
- L**
- limitations
 - dry-end limitations 11
 - measuring in high salinity 11, 13
 - temperature sensitivity 14
 - wet-end limitations 12–13
- M**
- maintenance 15
 - matric potential 11, 13, 14
 - moisture characteristic curve 11–12
- P**
- phone number 16, 17
- R**
- references 18
- S**
- specifications 7–8
- T**
- temperature 10, 13
 - terms and conditions 17–18
 - theory
 - dielectric permittivity 10, 13
 - dry-end limitations 11
 - measurement accuracy 12–13
 - measurement range 11–12
 - measuring in frozen soil 13–14
 - measuring in high salinity 11, 13
 - moisture characteristic curve 11
 - temperature measurement 13
 - temperature sensitivity 14
 - water potential 10
 - wet-end limitations 12–13
 - troubleshooting 16
- W**
- water content 10, 11, 15
 - water potential 12, 15. *See also* moisture characteristic curve; *See also* ceramic pore size
 - measurement 10, 16
 - wilting point 12